

# IDF-1008

The IDF-1008 inline duct filter can be used in most HVAC systems. Including fresh air intake, exhaust, passive air, and transit duct systems. Accepts standard size 20" x 20" x 2" replaceable filters. Ideal for larger spaces, the IDF-1008 is the perfect solution to retro fitting existing systems with in line duct filtration.

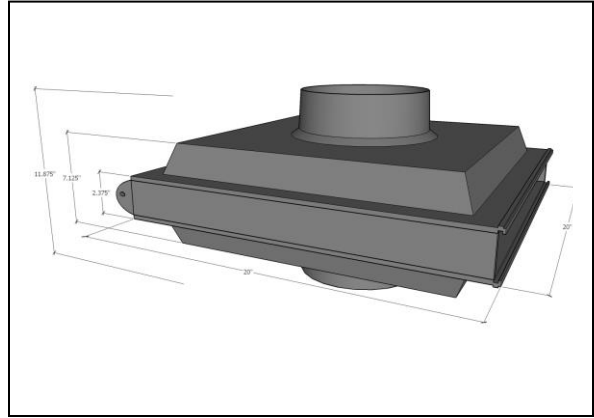

## Product Description:

<b>Retail Price:</b>	<b>\$209.95</b>
<b>Flange Size:</b>	<b>8" (d) x 2 1/2" (h)</b>
<b>CFM:</b>	<b>1000 CFM</b>
<b>Height:</b>	<b>20"</b>
<b>Length:</b>	<b>20"</b>
<b>Width:</b>	<b>12" with flanges</b>
<b>Installed Width:</b>	<b>6 1/2"- 7"</b>
<b>Weight:</b>	<b>2 1/2 lbs.</b>
<b>Material:</b>	<b>3/16" ABS plastic</b>
<b>Construction:</b>	<b>Vacuum formed, welded</b>
<b>Access:</b>	<b>Sliding Door</b>
<b>Filter Size:</b>	<b>20" x 20" x 2"</b>
<b>Filter Type:</b>	<b>Pleated, Panel, Carbon Cartridge</b>
<b>Warranty:</b>	<b>3 Years</b>