

IDF-1010

The IDF-1010 inline duct filter can be used in most HVAC systems. Including fresh air intake, exhaust, passive air, and transit duct systems. Accepts standard size 20" x 20" x 2" replaceable filters. Ideal for larger spaces, the IDF-1010 is the perfect solution to retro fitting existing systems with in line duct filtration.

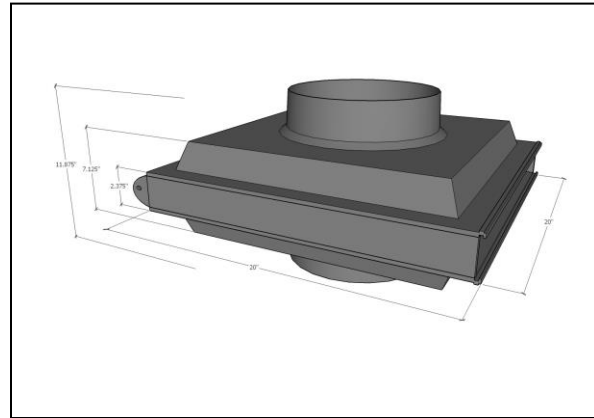

Product Description:

Retail Price:	\$219.95
Flange Size:	10" (d) x 2 1/2" (h)
CFM:	1000 CFM
Height:	20"
Length:	20"
Width:	12" with flanges
Installed Width:	6 1/2"- 7"
Weight:	2 1/2 lbs.
Material:	3/16" ABS plastic
Construction:	Vacuum formed, welded
Access:	Sliding Door
Filter Size:	20" x 20" x 2"
Filter Type:	Pleated, Panel, Carbon Cartridge
Warranty:	3 Years