

IDF-506

The IDF-506 inline duct filter can be used in most HVAC systems. Including fresh air intake, exhaust, ambient air, and transit duct systems. Accepts standard size 12" x 12" x 2" replaceable filters. Ideal for tight spaces, the IDF-506 is the perfect solution to retro fitting existing systems with in line duct filtration.

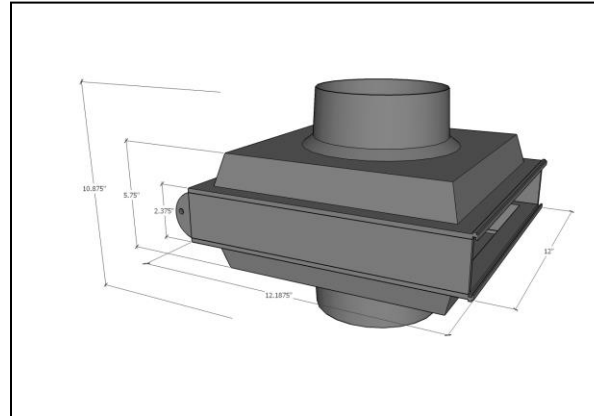

Product description:

Retail Price:	\$129.95
Flange Size:	6" (d) x 2 1/2" (h)
CFM:	500 CFM
Height:	12 3/16"
Length:	12"
Width:	11" with flanges
Installed Width:	5 1/2"- 6"
Weight:	1 1/2 lbs.
Material:	3/16" ABS plastic
Construction:	Vacuum formed, welded
Access:	Sliding Door
Filter Size:	12" x 12" x 2"
Filter Type:	Pleated, Panel, Carbon Cartridge
Warranty:	3 Years